

5

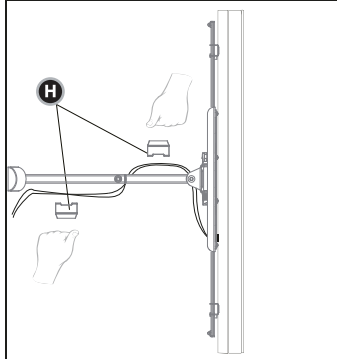
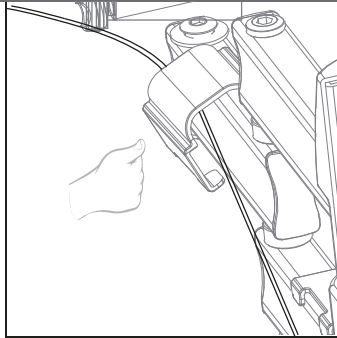
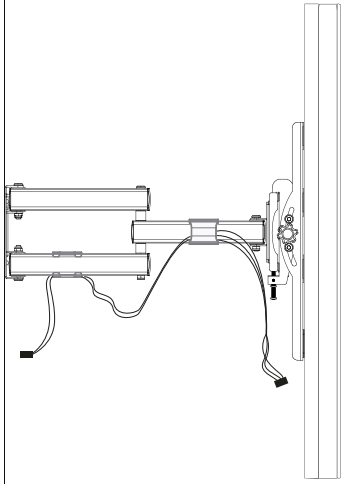

Slide the TV onto the bracket ensuring that the TV is centered onto the mount.

SET INCLUDES

A x1

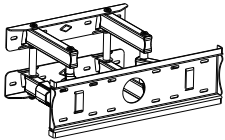

B x2



C x6



D x6



E₁ x4



M5

E₂ x4



M6

E₃ x4



M8

F x4



G x1



H x2



LN2RFM400

**Full motion
TV wall mount**

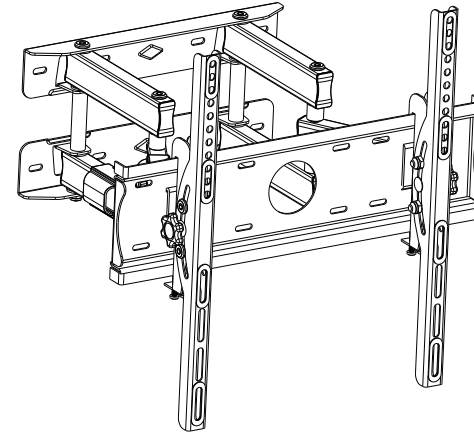

Easy installation:
Scan for installation video
For more information visit:
www.ross.uk

Whilst every effort has been made to ensure that the provided screws are suitable for connecting the mount to the vast majority of TV brands and models, Ross cannot be held responsible on the rare occasion that the supplied screws are not sufficient. Contact us for more information at help@ross.co.uk

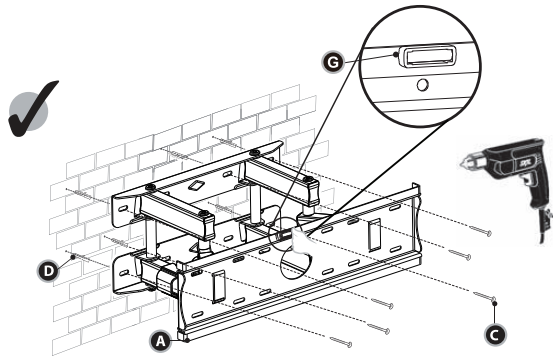
1

When selecting the position of the TV mount, ensuring that the mount will be mounted on to a flat surface and is level. Mark the wall where the fixing locations are. Drill the holes using a 10mm masonry bit. Using a hammer knock the the wall plugs (D) provided into the wall. Holding the TV mount start in the one corner screw the provided screws (C) into the wall fixing the opposite corners until the mount is secure onto the wall. Ensure all are tight and secure.

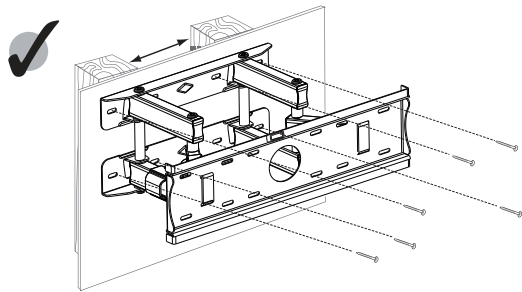

Using the provided self tapping screws (C) type. Holding the TV mount starting in the one corner, screw the provided screws (C) into a wooden joist fixing the opposite corners, until the mount is secure onto the wall. Ensure all are tight and secure.

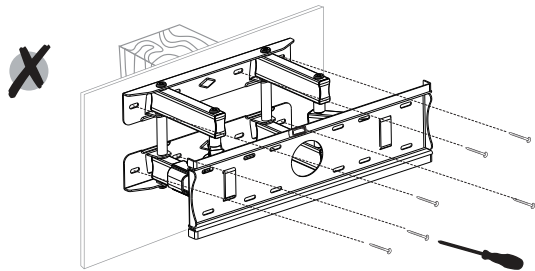

Ensure that the mount is fixed onto a solid surface and not directly onto plaster board.

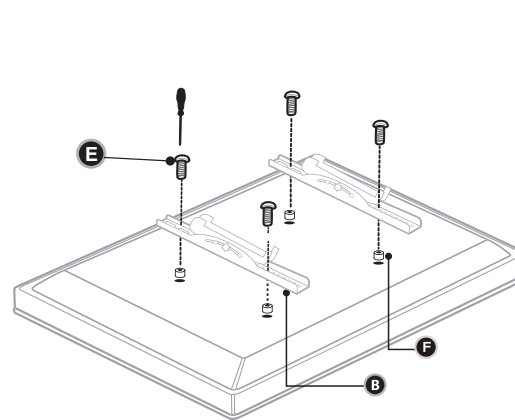
2

Taking note which end is the top of the TV, lie your TV onto the floor. Using the assortment of fixings provided select the appropriate ones to hold the hooks (E) onto the TV. Ensuring that the hooks are facing the the top end of your TV screw the hooks onto the TV ensuring not to over-tighten.

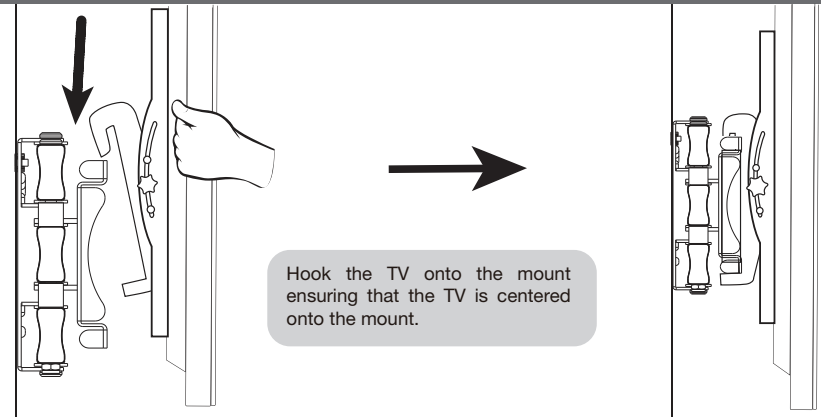
3

Hook the TV onto the mount ensuring that the TV is centered onto the mount.

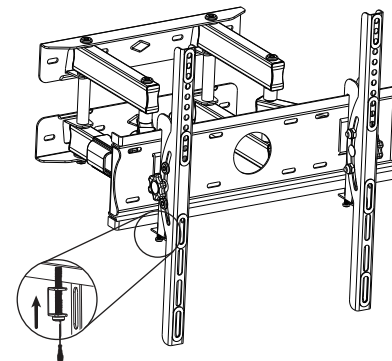
4

Using a screwdriver tighten the securing bolts onto the mount.